

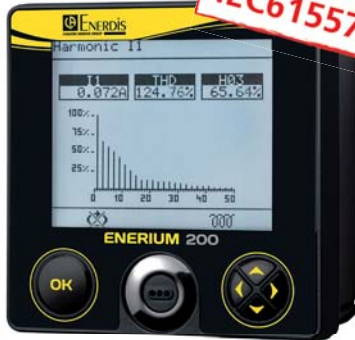

Multi-energy metering
(electricity, water, gas, etc.)
LV/MV/HV network monitoring
Energy quality

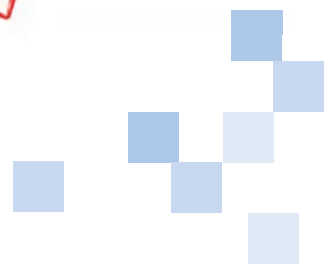

CLASS 0.2
IEC61557-12



ENERIUM

Multi-energy power monitors

Functions

Simple, intuitive and customizable interface for quick access to the information that you need.

Real-time display

of instantaneous, average, min and max values.

Time/date-stamped recording

of min and max values

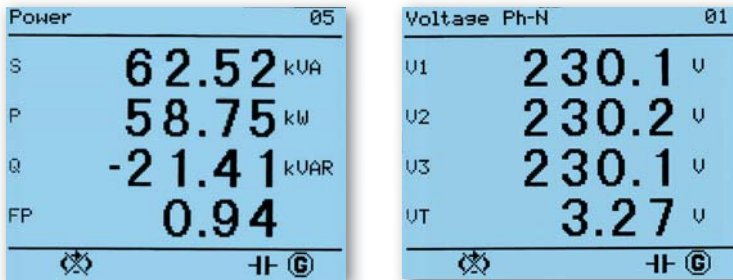

Alarms

- 16 programmable alarms on instantaneous, average, min and max values, as well as analogue and on-off inputs (e.g. circuit-breaker status)
- Recording of the last 64 events (values, dates, times, durations)
- Flashing display if there is an alarm

Alarmes		
Numéro	Statut	Relais
1	-	-
2	-	-
3	-	-
4	-	-
5	-	-
6	-	-
7	-	-
8	-	-
9	-	-
10	-	-
11	-	-
12	-	-
13	-	-
14	-	-
15	-	-
16	-	-



Graphics for easier data analysis

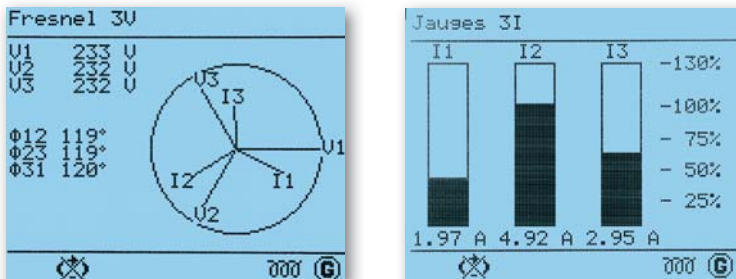

- Checking of connections, unbalance measurement and display of phase shift
- Monitoring of load factor (display of V, U, I and P)



Indication of connection errors

before operation begins

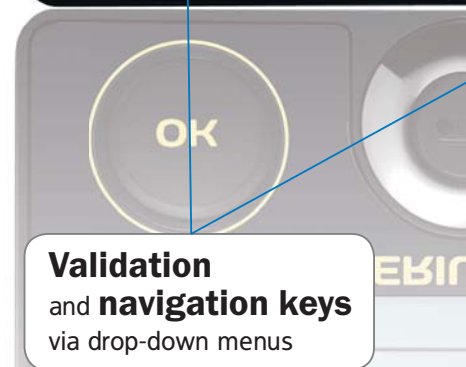

Validation and **navigation keys** via drop-down menus





Local access via **USB cable/**
optical head for:
- programming
- reading the data
- upgrading the firmware



Recording

- Indices, consumption curves ⁽¹⁾ (electricity, water, gas, etc.) and temperature curves ⁽¹⁾
- Critical parameters with triggering according to 3 different modes (date, alarm, on-off input) and possibility of pre/post trigger ⁽²⁾

(1) Load curves. (2) Trend curves.



Preventive maintenance

- Installation operating time
- Operating time of monitored equipment



Quick programming

- Current transformer ratios and communication parameters can be set on the front panel or remotely
- Possibility of protection by password



Customizable screens

- 3 screens with 4 display lines each to organize the information as you wish



Harmonic analysis

- Measurement of THD per phase on U, I and In
- Spectral analysis per phase up to the 50th order on U, I and In

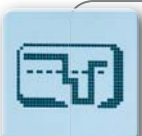
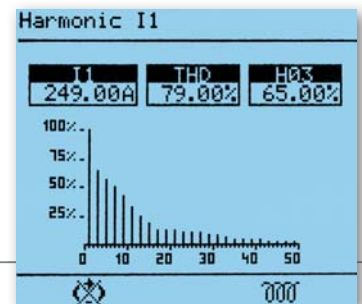

Qualimetry

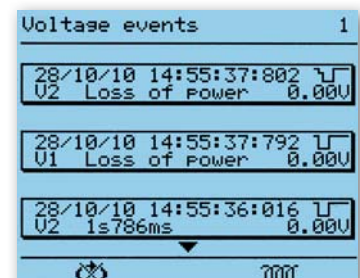
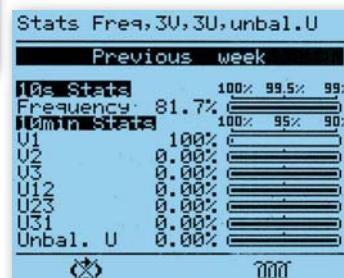

- Statistical analysis graphs as per EN50160

- Log of the last 1024 events (dips, outages, overvoltages, overcurrents)
Waveform capture (V-U-I-In)

Multiple applications

In addition to the generic functions of power monitors, the ENERIUM range also offers extensive, customizable communication functions.

ANALOGUE INPUTS

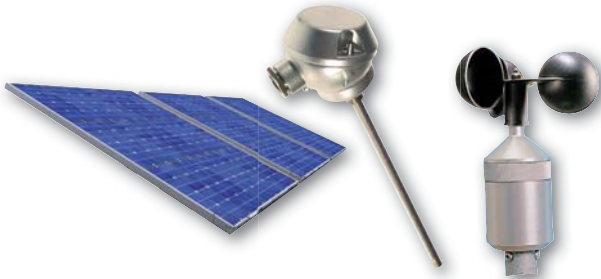

METERING INPUTS

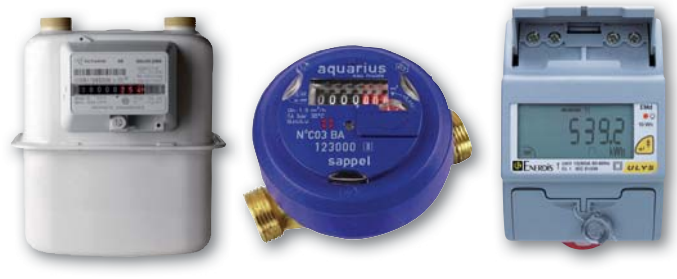

insolation, weather data, temperatures, etc.

water, gas, electricity

CURRENT AND VOLTAGE INPUTS – LV/MV/HV NETWORKS



ANALOGUE OUTPUTS



ALARM RELAY OUTPUTS



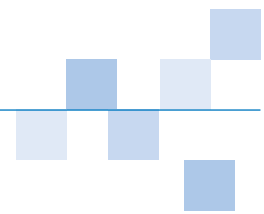

SYNCHRO PULSE INPUTS

STORAGE OF STATUSES AND ALARMS

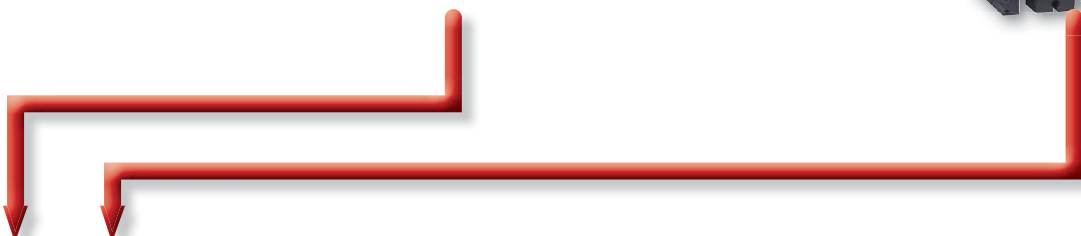

E.ONLINE® ENERGY MANAGEMENT SOFTWARE



PLCs FOR CTM/TBM SUPERVISION



PLC OUTPUTS (ALARM/PULSE)



Choose your power monitor

ENERIUM[®], THE TECHNOLOGICAL REFERENCE for everything from basic applications (secondary switchboard, load monitoring) to the most demanding tasks (metering station).



ELECTRICAL ENERGY

MULTI-ENERGY

QUALIMETRY

Functional specifications	ENERIUM 30	ENERIUM 50	ENERIUM 150	ENERIUM 100	ENERIUM 200	ENERIUM 300
Accuracy class (IEC61557-12)	1	0.5	0.5	0.5	0.5 ou 0.2	0.2
Format	96 x 96 mm	96 x 96 mm	96 x 96 mm	144 x 144 mm	144 x 144 mm	144 x 144 mm
Graphic LCD screen	●	●	●	●	●	●
Version without display	–	–	–	Enerium 110	Enerium 210	Enerium 310
Mounting	Flush-mounted, DIN rail* or plate-mounted*	Flush-mounted, DIN rail* or plate-mounted*	Flush-mounted, DIN rail* or plate-mounted*	Flush-mounted, DIN rail* or plate-mounted* (Enerium 110)	Flush-mounted, DIN rail* or plate-mounted* (Enerium 210)	Flush-mounted, DIN rail* or plate-mounted* (Enerium 310)
Harmonics						
Max. order	–	25	50	25	50	50
Recording functions						
8 load curves	–	●	●	–	●	●
4 trend curves	–	–	●	●	●	1
Alarms						
Number of alarms	2	16	16	16	16	16
Time/date-stamped events recorded	–	64	64	64	64	64
Qualimetry functions						
Qualimetry according to EN50160	–	–	–	–	–	●
V, U, I and In waveform capture	–	–	–	–	–	16
Storage of last 1024 events (dips, outages, overvoltages) with time/date-stamping	–	–	–	–	–	●
Inputs / outputs						
Max. number	1	2	2	8	8	8
Inputs (optional)						
On-off (pulses or alarm)	–	0,1 or 2	0,1 ou 2	0, 2, 4, 6 or 8	0, 2, 4, 6 or 8	0, 2, 4, 6 or 8
Analogue	–	–	–	–	–	–
Outputs (optional)						
On-off (pulses or alarm)	1	0,1 or 2	0,1 or 2	0, 2, 4, 6, or 8	0, 2, 4, 6, or 8	0, 2, 4, 6, or 8
Analogue	0	0 or 2	0 or 2	0.2 or 4	0.2 or 4	0.2 or 4
Graphics						
Fresnel	–	–	●	●	●	●
Gauges	●	–	●	–	–	–
Histograms of harmonic orders	–	–	●	–	●	●
Communication interface						
Optical / USB	–	Front	Front	Front or rear	Front or rear	Front or rear
Ethernet or RS485	RS485	●	●	●	●	●
Metrological LED	–	–	–	●	●	●
Other functions						
Programming on front panel	●	●	●	●	●	●
Programming via software	–	●	●	●	●	●

* With mounting kit

Advantages



An optical head/USB connection for:

- Programming
- Reading the data
- Upgrading the software

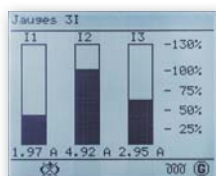

Display with graphics (Fresnel, gauges, harmonics)



Screenless version for DIN-rail or plate mounting (ENERIUM 110/210/310)



Up to 8 on-off or analogue inputs/outputs

and related software

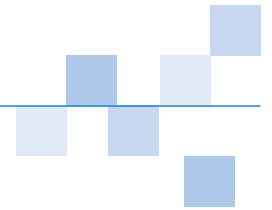

[.view

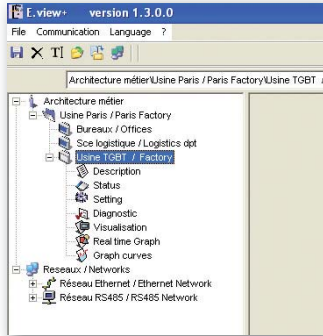

Architecture:

- Display of the electrical installation's architecture

Instantaneous			
Voltage	V1	V2	V3
Ph-H (V)	229,31	229,01	229,86
Ph-Ph (V)	0,00	0,00	0,00
U-Earth (V)	0,00		
Unb. Ph-Ph (%)	0,00		
Frequency (Hz)	50,00		

Display:

- All the quantities managed by the power monitor
- Reading of 1 s, average, min and max values with time/date-stamping

THD			
Voltage [1s]	V1	V2	V3
Ph-H (%)	1,52	1,53	1,54
Ph-Ph (%)	0,00	0,00	0,00

Summary tables:

- Simplified analysis of the results
- Alarms log
- Statistics compliant with EN50160
- Time/date-stamped events (*dips, outages, overvoltages, etc.*)



Data export:

- Alarms log
- EN50160 statistics
- Voltage events (*dips, outages, overvoltages, etc.*)
- Waveforms
- Multiple export formats: .csv, .xls, .txt, etc.

[.view +

Energy management:

- Display of load curves
- Comparison of energy consumption with temperature curves

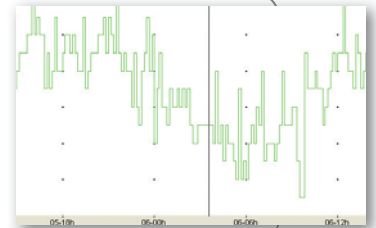

Installation monitoring:

- Recording of critical parameters
- Analysis of recordings after triggering by alarm

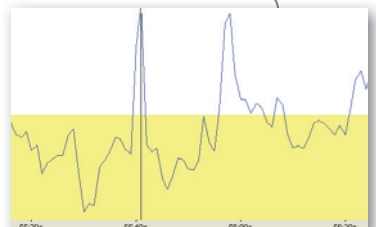

Harmonic analysis:

- Simplified analysis of the results by means of graphics

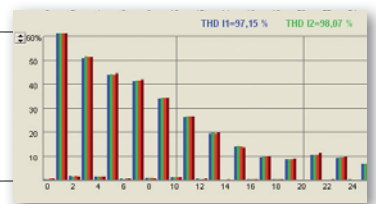

Phase shift measurement:

- Implementation made easier by simple visual check
- Measurement of phase angles and unbalance (V, U, I)

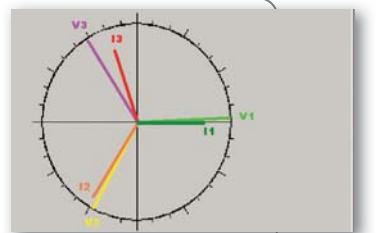

Related software

Functions	[.set ^{(1) (2)}	[.view ⁽²⁾	[.view + ⁽²⁾
Creation of network architecture	●	●	●
Configuration (remote or local)	●	●	●
Data display and export		●	●
Graphics			●

(1) delivered as standard with each instrument
 (2) Except on Enerium 30

Functions

Measurements

	1 S	min	max	average	min average	max average
V, U	●	○	●	●		○
Vearth	○	○	○	○		○
I	●	○	●	●		○
In (calculated or measured) ⁽¹⁾	●	○	●	●	○	○
P (4 quadrants)	●		○	○		
Pt (4 quadrants)	●	●	●	○		○
Q (4 quadrants)	●		○	○		
Qt (4 quadrants)	●	○	●	●		○
S	●		○	○		
St	●	●	●	●		○
FP (4 quadrants)	●			○		
FPt (4 quadrants)	●			●	○	○
Cosφ (4 quadrants)	○			○		
Cosφt (4 quadrants)	○	○	○	○	○	○
Tanφt (4 quadrants)	●			●	○	○
Frequency	●	○	●	○		
V crest factor	○			○		○
I crest factor	○			○		○
U unbalance	○			○		○
Harmonics on V, U, I	○					
Harmonics on In	○					
THD V, U, I	●			●		○
THD In	●		○	●		○
Active energy (receiver, generator)	●			●		○
Reactive energy (Qcad1, 2, 3, 4)	●					
Apparent energy (receiver, generator)	●					
On-off input (pulse mode)	○					
Analogue input (Enerium 100/200)	○	○	○	○	○	○
Voltage presence hour meter (U)	○					
Load hour meter (I)	●					
Auxiliary power supply hour meter	●					

○ Except on 30

⁽¹⁾ on Enerium 30/50/150, calculated only

Connection diagrams

Single-phase

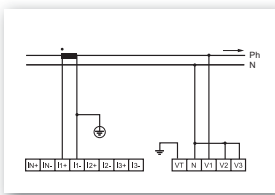

Balanced 3-phase, 4 wires - 1 CT Except on Enerium 30

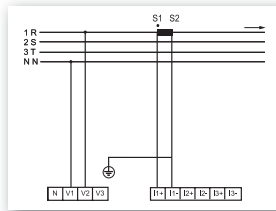

Balanced 3-phase, 4 wires - 1 CT Enerium 30 only

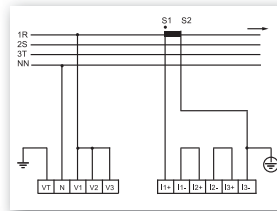

Balanced 3-phase, 3 wires - 1 CT Enerium 30 only

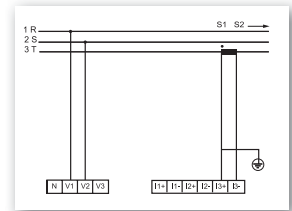

Unbalanced 3-phase, 4 wires - 3 CTs

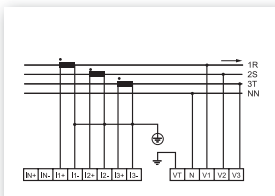

Unbalanced 3-phase, 4 wires - 4 CTs Except on Enerium 30/50/150

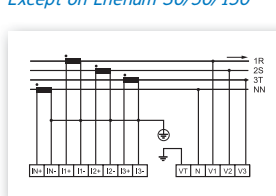

Unbalanced 3-phase, 3 wires - 3 CTs

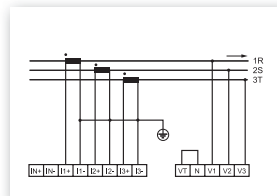

Unbalanced 3-phase, 3 wires - 2 CTs

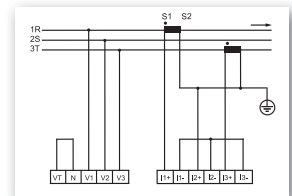

Example of connection to VT

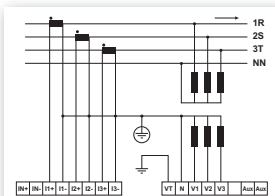

Trend curves

(except on Enerium 30/50)

1S VALUES	
V, Vearth	●
U12, U23, U31	●
I1, I2, I3, In	●
Pt	●
Qt	●
St	●
PFt	●
U unbalance	●
THD V, U, I, In	●
Analogue inputs (Enerium 100/200 only)	●
AVERAGE VALUES	
V1, V2, V3	●
U12, U23, U31	●
I1, I2, I3, In	●
Gen: P1, P2, P3, Pt	●
Rec: P1, P2, P3, Pt	●
Analogue inputs (Enerium 100/200 only)	●
Gen: PF1, PF2, PF3, PFt	●
Rec: PF1, PF2, PF3, PFt	●
Gen: Cosφ1, Cosφ2, Cosφ3, Cosφt	●
Rec: Cosφ1, Cosφ2, Cosφ3, Cosφt	●
Tanφt	●
Frequency	●
Crest factor V1, V2, V3	●
Crest factor I1, I2, I3	●
THD U12, U23, U31	●
THD I1, I2, I3, Ineutral	●
THD V1, V2, V3	●

Load curves

(except on Enerium 30/100 and 110)

AVERAGE VALUES	
Pt Gen, Pt Rec	●
Qcad1, Qcad2, Qcad3, Qcad4,	●
St Gen, St Rec	●
On-off inputs	●
Analogue inputs (Enerium 200 only)	●

Accessories

Kit for DIN-rail or plate mounting



Dimensions

ENERIUM 30/50/150

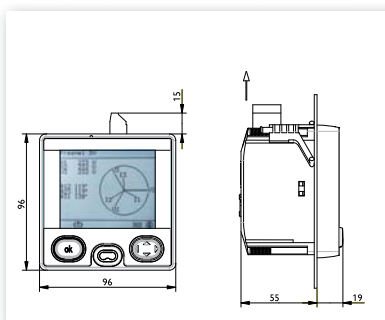

ENERIUM 100/200/300

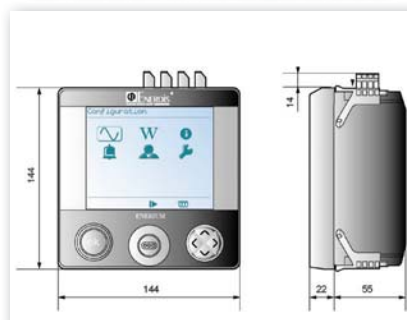

ENERIUM 110/210/310

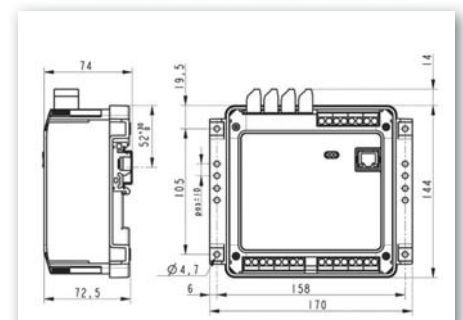

Alarms

1S VALUES	
V1, V2, V3	●
Vearth	○
U12, U23, U31	●
I1, I2, I3, In	●
Pt	●
Qt	●
St	●
PFt	●
Cosφt	○
Tanφt	●
Frequency	●
U unbalance	○
THD V, U, I, In	○
3 hour meters: network presence, on-load presence, aux. source	○
Analogue inputs (Enerium 100/200 only)	○
AVERAGE VALUES	
Pt Gen, Pt Rec	○
Qt Gen, Qt Rec	○
St	○
Tanφt (except on Enerium 30/50/150)	○
Analogue inputs (Enerium 100/200 only)	○
ON-OFF INPUTS (Enerium 100/200 only)	
	●

○ Except Enerium 30

Analogue outputs (option)

(Except Enerium 30)

1S VALUES	
V1, V2, V3, Vearth	●
U12, U23, U31	●
I1, I2, I3, In	●
Pt	●
Q1, Q2, Q3	●
Qt	●
S1, S2, S3	●
St	●
PF1, PF2, PF3	●
PFt	●
Cosφ1, Cosφ2, Cosφ3,	●
Cosφt,	●
Tanφt,	●
Frequency	●

Specifications

	ENERIUM 30 Class 1	ENERIUM 50/150 Class 0.5 s	ENERIUM 100/200 Class 0.5 s	ENERIUM 200 Class 0.2 s	ENERIUM 300 Class 0.2 s
Electrical network					
Max. phase-to-phase voltage measured	650 kV				
VT ratio	VT primary: 100 V to 650 kV VT secondary: 100 V to 480 V				
Max. current measured	25,000 A				
CT ratio	CT primary: 1 A to 25,000 A CT secondary: 1 A or 5 A				
Max. power measured	2 GW				
Voltage inputs (AC)					
Measurement range	5 to 130 % of V_n for $V_n = 57.7 / 230$ V (ph-N) 5 to 130 % of U_n for $U_n = 100 / 400$ V (ph-ph)				
Crest factor	2				
Measurement accuracy (U and V)	0.5 % from 20 % to 130 % of U_n / V_n	0.2 % from 20 % to 130 % of U_n / V_n			
Overvoltage	Transient $U = 800$ V for 24 hours Permanent 130 % of 400 V = 520 V				
Frequency	50 / 60 Hz	50 / 60 Hz or 400 Hz	50 / 60 Hz	50 / 60 Hz or 400 Hz	50 / 60 Hz
Consumption	< 0.1 VA	< 0.15 VA	< 0.1 VA		
Input impedance	0.45 M Ω	0.44 M Ω	1 M Ω		
Current inputs (AC)					
Measurement range	1 % to 130 % of I_n for $I_n = 5$ A				
Crest factor	3				
Measurement accuracy	0.5 % from ≥ 10 % to ≤ 130 %	0.2 % from ≥ 10 % to ≤ 130 % 0.5 % from ≥ 5 % to ≤ 10 % 1 % from ≥ 1 % to ≤ 5 %			
Acceptable overload	Transient $I = 250$ A for 1 second Permanent 130 % of 5 A = 6.5 A				
Consumption	< 0.15 VA				
Compliance with standards					
EN62053-22	Active energy Class 1 Reactive energy Class 2	Active energy Class 0.5 s		Active energy Class 0.2 s	Active energy Class 0.2 s
IEC61557-12 PMD SD/SS	V,I Class 0.5 P,S Class 0.5	V,I Class 0.2 P,S Class 0.5	class 0.5	class 0.2	class 0.2
		Active energy Class 0.5 Reactive energy Class 0.5		Active energy Class 0.2 Reactive energy Class 0.5	Active energy Class 0.2 Reactive energy Class 0.2
Multi-measurement (accuracies)					
Active power and energy	1 % for 5 % $I_n \leq I \leq I_{max}$	0.5 % for 5 % $I_n \leq I \leq I_{max}$		0.2 % for 5 % $I_n \leq I \leq I_{max}$	
Reactive power and energy	2 % for 5 % $I_n \leq I \leq I_{max}$	0.5 % for 5 % $I_n \leq I \leq I_{max}$			
Apparent power and energy	1 % for 5 % $I_n \leq I \leq I_{max}$	0.5 % for 5 % $I_n \leq I \leq I_{max}$			
Power factor (PF) and $\cos\varphi$	± 0.05 counts when 0.5 inductive < PF < 0.5 ± 0.1 counts when 0.2 inductive < PF < 0.2 capacitive	± 0.02 counts when 0.5 inductive < PF < 0.5 capacitive ± 0.05 counts when 0.2 inductive < PF < 0.2 capacitive			
Frequency	$\pm 0.1\%$ from 42.5 to 69 Hz				
Sampling frequency	6.4 kHz to 50 Hz				
THD-I, THD-V and THD-U	± 0.5 counts				
Harmonics order by order	–	± 0.5 counts			

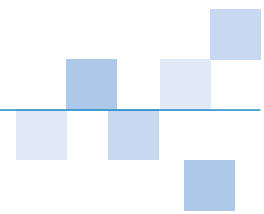

	ENERIUM 30 Class 1	ENERIUM 50/150 Class 0.5 s	ENERIUM 100/200 Class 0.5 s	ENERIUM 200 Class 0.2 s	ENERIUM 300 Class 0.2 s
RS485 output					
Connection	2 wires, half duplex				
Protocol	ModBus / JBus RTU mode				
Speed (configurable)	2,400 - 4,800 - 9,600 - 19,200 - 34,800 (115,200 on ENERIUM 50/150)				
Parity	Even, odd or none				
JBus addresses	1 to 247				
Ethernet output					
Type	-	RJ45 - 8 pins			
Protocol	-	ModBus/TCP			
Speed (configurable)	-	Compatible with 10, 100 and 1,000 base T			
Auxiliary power supply					
Power supply	230...400 Vac ± 20 % (< 10 VA)	80 to 265 Vac (< 15 VA) 42.5 to 69 Hz 110 to 375 Vdc 19 to 57 Vdc (< 7.5 W)	80 to 265 Vac (< 20 VA) - 42.5 to 69 Hz 110 to 375 Vdc 19 to 57 Vdc (< 10 W)		
Digital inputs (on-off or metering pulse)					
Operating voltage	-	Up to 70 Vdc max.	High level: 10 to 70 Vdc Low level: 0 to 5 Vac		
Min. signal width	-	High level: 30 ms Low level: 30 ms			
Consumption	-	< 0.5 W			
Pulse or alarm relay outputs					
Type	Static relay				
Operating voltage	70 Vdc max 33 Vac max	24 to 110 Vdc ± 20 % 24 to 230 Vac ± 10%			
Max. current	100 mA	100 mA			
Compliance with standard	IEC 62053-31				
Analogue inputs					
Scale	-	-	Configurable between -20 to +20 mA		
Power consumption	-	-	< 50 mW		
Input impedance	-	-	50 Ω		
Analogue outputs					
Scale	-	Configurable between -20 to + 20 mA			
Acceptable overload	-	500 Ω			
Response time	-	< 500 ms			
Storage					
Non-volatile memory	Configuration parameters – Recordings (curves, alarms, min-max, qualimetry events log, IEC 50160 statistics)				
RAM	Capture of waveforms				
Environmental specifications					
Operating temperature	- 10 °C to + 55 °C (K55 according to IEC61557-12)				
Operating humidity	95 % to 40 °C				
Storage temperature	- 25 °C to + 70 °C				
Safety specifications					
Pollution	2				
Behaviour in fire	UL 94, severity V1				
Installation category	3				

To order

Standard ENERIUM

Model	Frequency	Accuracy class	Power supply	Communication	On-off inputs	On-off outputs	Analogue outputs	Reference
ENERIUM 30	50 / 60 HZ	1	230 to 400 Vac/Vdc	-	0	0	0	P01330821
ENERIUM 30	50 / 60 HZ	1	230 to 400 Vac/Vdc	-	0	1	0	P01330822
ENERIUM 30	50 / 60 HZ	1	230 to 400 Vac/Vdc	RS485	0	0	0	P01330823
ENERIUM 30	50 / 60 HZ	1	230 to 400 Vac/Vdc	RS485	0	1	0	P01330824
ENERIUM 50	50 / 60 HZ	0.5 s	80 to 265 Vac / 110 to 375 Vdc	RS485	0	0	0	P01330805
ENERIUM 50	50 / 60 HZ	0.5 s	80 to 265 Vac / 110 to 375 Vdc	Ethernet	0	0	0	P01330806
ENERIUM 50	50 / 60 HZ	0.5 s	80 to 265 Vac / 110 to 375 Vdc	RS485	1	1	0	P01330807
ENERIUM 50	50 / 60 HZ	0.5 s	80 to 265 Vac / 110 to 375 Vdc	Ethernet	1	1	0	P01330808
ENERIUM 150	50 / 60 HZ	0.5 s	80 to 265 Vac / 110 to 375 Vdc	RS485	0	0	0	P01330809
ENERIUM 150	50 / 60 HZ	0.5 s	80 to 265 Vac / 110 to 375 Vdc	Ethernet	0	0	0	P01330810
ENERIUM 150	50 / 60 HZ	0.5 s	80 to 265 Vac / 110 to 375 Vdc	RS485	0	2	0	P01330811
ENERIUM 150	50 / 60 HZ	0.5 s	80 to 265 Vac / 110 to 375 Vdc	Ethernet	0	2	0	P01330812
ENERIUM 100	50 / 60 HZ	0.5 s	80 to 265 Vac / 110 to 375 Vdc	RS485	0	0	0	P01330831
ENERIUM 100	50 / 60 HZ	0.5 s	80 to 265 Vac / 110 to 375 Vdc	RS485	2	2	0	P01330832
ENERIUM 200	50 / 60 HZ	0.5 s	80 to 265 Vac / 110 to 375 Vdc	RS485	4	2	0	P01330833
ENERIUM 200	50 / 60 HZ	0.5 s	80 to 265 Vac / 110 to 375 Vdc	Ethernet	2	2	2	P01330834
ENERIUM 210	50 / 60 HZ	0.5 s	80 to 265 Vac / 110 to 375 Vdc	Ethernet	8	0	0	P01330835
ENERIUM 300	50 / 60 HZ	0.2 s	80 to 265 Vac / 110 to 375 Vdc	RS485	0	0	0	P01330816
ENERIUM 300	50 / 60 HZ	0.2 s	80 to 265 Vac / 110 to 375 Vdc	Ethernet	0	0	0	P01330817
ENERIUM 300	50 / 60 HZ	0.2 s	19 to 58 Vdc	RS485	0	0	0	P01330818
ENERIUM 300	50 / 60 HZ	0.2 s	19 to 58 Vdc	Ethernet	0	0	0	P01330819

Configured products

ENERIUM

1 2 3 4 5 6 7 8 9

1 Model

- 50 ENERIUM 50 – Electrical energy – Load curves - Format 96 x 96
- 150 ENERIUM 50 + Trend curves - Format 96 x 96
- 100 ENERIUM 100 – Multi-energy - Trend curves - Format 144x144
- 110 ENERIUM 100 screenless version - Format 144x144
- 200 ENERIUM 100 + Load curves - Format 144x144
- 210 ENERIUM 200 screenless version - Format 144x144
- 300 ENERIUM 200 + Qualimetry
- 310 ENERIUM 300 screenless version

2 Frequency of network measured

- 0 50 / 60 Hz
- 1 400 Hz (except on Enierium 100 / 200 class 0.5s / 300)

3 Auxiliary power supply

- 0 80 to 265 Vac / 110 to 375 Vdc
- 1 19.2 to 58 Vdc

4 Communication

- 0 RS485
- 1 Ethernet

Note: with choices 5, 6, 7 and 8, it is possible to have a maximum of 8 inputs and/or outputs (ENERIUM 100-110/200-210).

Note: for the Enierium 50/150, choices 5 and 6 only allow the following combinations: 0-0, 1-1, 2-0, 0-2.

5 Metering (or On-Off) inputs

- 0 none
- 1 1 input (only on ENERIUM 50/150)
- 2 2 inputs
- 4 4 inputs (except on ENERIUM 50/150)
- 6 6 inputs (except on ENERIUM 50/150)
- 8 8 inputs (except on ENERIUM 50/150)

6 On-Off outputs

- 0 none
- 1 input (only on ENERIUM 50/150)
- 2 2 inputs
- 4 4 inputs (except on ENERIUM 50/150)
- 6 6 inputs (except on ENERIUM 50/150)
- 8 8 inputs (except on ENERIUM 50/150)

7 Analogue inputs (ENERIUM 100/200 only)

- 0 none
- 2 2 analogue inputs
- 4 4 analogue inputs
- 6 6 analogue inputs
- 8 8 analogue inputs

8 Analogue outputs

- 0 none
- 2 2 outputs
- 4 4 outputs (except on ENERIUM 50/150)

9 Accuracy class

- 5 0.5 s (except on ENERIUM 300)
- 2 0.2s (ENERIUM 200/210/300/310 only)

Example: Enierium 200, frequency 50/60 Hz, 80 to 264 Vac auxiliary power supply, RS485 communication, 2 on-off inputs, no on-off outputs, no analogue inputs, no analogue outputs, Class 0.2s

=> order ENERIUM 200 01020002 • 1-200 • 2-0 • 3-1 • 4-0 • 5-2 • 6-0 • 7-0 • 8-0 • 9-2

Logiciels

E.set	P01330501
E.View	P01330601
E.View+	P01330610

Accessories

Optical head for ENERIUM 50/150	P01330403
Optical head for ENERIUM 100/110 - 200/210 – 300/310	P01330401
DIN-rail mounting kit for ENERIUM 30/50/150	P01330830
DIN-rail mounting kit for ENERIUM 100/200/300	P01330360
690 V / 400 V resistive voltage adapter (for wind-turbine applications)	P01330402
Power supply for On-Off inputs 85 to 256 Vac/12 Vdc – 3.5 A (42 W)	ACCJ1004